

**FEATURES**

**Motion and audio control**

- MiniSSC, SMI, SV203, Parallax, Pololu, PicoPic, SSC32, K108A, DMX and compatible devices
- Digital 44.1kHz stereo MP3 audio
- As many as 32 devices
- High-speed servo/motor/relay serial port
- DMX output port
- TTL output port
- VSA playback compatibility
- Integrated VSA development support

**Flexible user interface**

- On-board LCD and keys
- Remote serial port
- Infrared remote control
- Internal digital clock for triggered playback

**Expandable routine management**

- Secure Digital (SD/SDHC) memory card slot
- USB 1.1 upload port
- Multiple playback modes
- Unlimited routine length support

**Applications**

- DJ stage lighting
- Production and prototype animatronics
- Open-loop robotics control
- Theme park and ride attractions
- Theatrical prop and stage automation
- Museum and store-front displays
- Haunted houses
- Holiday display animations

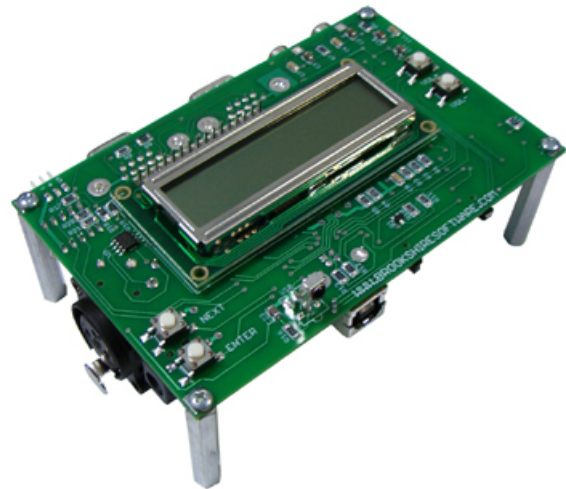

**GENERAL DESCRIPTION**

The Remote Advanced Playback Unit (RAPU) v4.0 liberates productions from the PC. The RAPU is a plug-and-go replacement for the PC. Take productions and animations perfected on the PC with VSA, upload them to the RAPU via USB, and breathe new realism into the show. The RAPU is the most accurate and advanced solution for production and show control with audio.

The RAPU can control up to 32 devices including MiniSSC servos, SMI motors, SV203 servos and relays, Parallax servos, Pololu servos, PicoPic servos and relays, LynxMotion SSC32 servos and relays, K108A relays, BoC DMX servos, generic DMX devices, and any compatible hardware. The internal clock can be configured to playback routines at predefined dates and times. The system can be operated at a variety of frame and baud rates. The 4.5" x 3" circuit board can be controlled via its remote serial port, infrared remote control, or from the built in LCD interface. Identical to VSA playback, the RAPU outputs synchronized digital stereo MP3 audio on two RCA jacks. The MP3 audio and device data are stored on a standard Secure Digital (SD/SDHC) card and can be uploaded to the device through the USB interface.

The RAPU v4.0 is fully supported in VSA v4.0 and uses the included RAPU Manager software to upload routines.

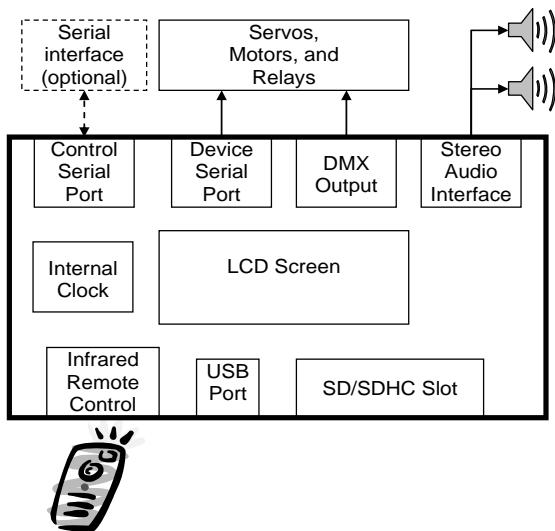

## Table of Contents

1	Introduction.....	1
1.1	Unpacking the RAPU .....	1
1.2	Connector Diagram .....	1
1.3	Technical Specifications.....	2
1.4	Install Visual Show Automation .....	2
1.5	Installing the RAPU Manager .....	2
1.5.1	Windows XP.....	2
1.5.2	Windows Vista.....	3
1.6	Setting up the RAPU .....	4
1.7	Mounting .....	4
2	Using the RAPU .....	4
2.1	Creating Routines .....	4
2.2	Uploading .rapu files.....	5
2.3	Playing routines.....	5
2.4	Error messages.....	6
2.5	IR Remote control .....	6
2.5.1	Programming the IR remote control .....	7
2.6	Repeater Operation.....	8
2.7	Scheduler .....	8
2.7.1	Set the date and time .....	9
2.7.2	Schedule events.....	9
2.8	Control serial port.....	9
2.9	Upgrading the Firmware.....	11

# 1 Introduction

## 1.1 Unpacking the RAPU

Thank you for purchasing your new RAPU by Brookshire Software, LLC. Please visit our website at <http://www.brookshiresoftware.com> for the latest updates and documentation. When you first receive your RAPU, check to be sure the following items are included. If any items are missing, please immediately return the unit to the place of purchase.

- The RAPU v4.0
- Infrared remote control
- USB cable
- Power supply

The RAPU will also require that the servos, motors, relays and other control hardware be powered and operational. We suggest that you verify control hardware operation using VSA before migrating to the RAPU. Additionally, a standard Secure Digital (SD/SDHC) card will be needed to store routines.

## 1.2 Connector Diagram

Use the following diagram to become familiar with the physical aspects of the RAPU.

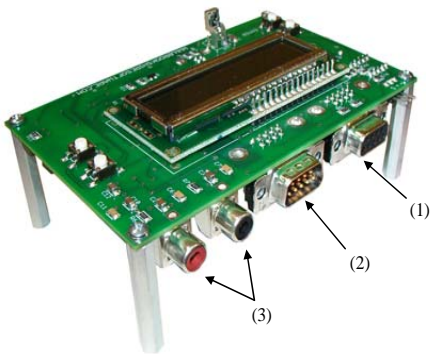

- (1) Control serial port
- (2) Device serial port
- (3) Audio RCA jacks
- (4) LCD screen
- (5) DMX output port
- (6) Power connector
- (7) Infrared receiver

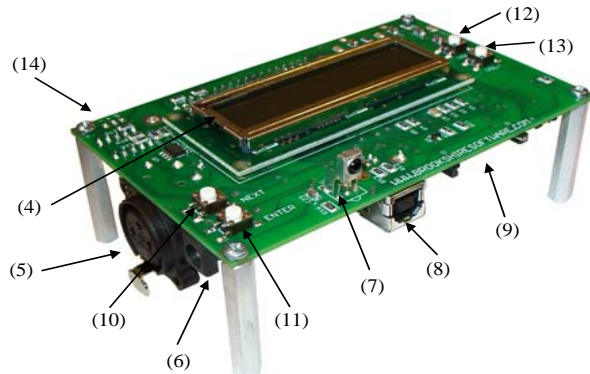

- (8) USB port
- (9) SD/SDHC slot
- (10) *Next* key
- (11) *Enter* key
- (12) +VOL key
- (13) -VOL key
- (14) TTL port

### 1.3 Technical Specifications

Parameter	Value
Voltage Supply	6 – 8 VDC
Current Consumption	300 mA
Audio connectors	One left and one right RCA jack
Maximum audio current	50 mA
Playback Modes	Play single routine, repeat single routine, repeat all routines, play random routine
Baud Rates (non-repeater mode)	2400, 4800, 9600, 19200, and 38400 bps
Baud Rates (repeater mode only, see Section 2.6)	2400, 4800, 9600, 19200, 38400, 57600, and 115200 bps
Device Support	MiniSSC, SMI, SV203, Parallax, Pololu, PicoPic, LynxMotion SSC32, K108A, DMX and compatible
Frame Rates	33, 50, 66, 100, and 200 FPS
Internal digital clock	Initiate playback on any combination of month, day of month, weekday, hour, or minute.

### 1.4 Install Visual Show Automation

Refer to the Visual Show Automation Getting Started Guide for details on how to install the software. Visit [http://www.brookshiresoftware.com/vsa\\_downloads.htm](http://www.brookshiresoftware.com/vsa_downloads.htm) for more details.

### 1.5 Installing the RAPU Manager

The RAPU Manager must be installed before the RAPU is linked to the PC via USB. The RAPU Manager requires Windows XP SP2 or Windows Vista (both 32 and 64 bit versions are supported. Windows 95, 98, ME, and XP SP1 are not supported. Installing the RAPU Manager will install all necessary software and drivers. If installing on Windows Vista, see Section 1.5.2.

1. Download the RAPU Manager and remember the destination directory.
2. Select **Run** from the Windows **Start** menu.
3. Enter **C:\Download\rm\_setup\_web.exe** (or **rm\_setup\_cd.exe**) where “C:\Download\” is the directory to which you saved the download (from step 1).
4. Follow the on-screen prompts to install the software and drivers.
5. When finished, select the **RAPU Manager** program group from the Windows **Start | Programs** menu.
6. Select **RAPU Manager** to start the upload software.

#### 1.5.1 Windows XP

When linking the RAPU to the PC with USB (see Section 2.2) for the first time on Windows XP, you will be prompted by the Windows Hardware Wizard as shown below. Follow the

preceding steps (see in Section 1.5) to install the RAPU Manager software. Then, choose to “Install the software automatically” and press “Next.”

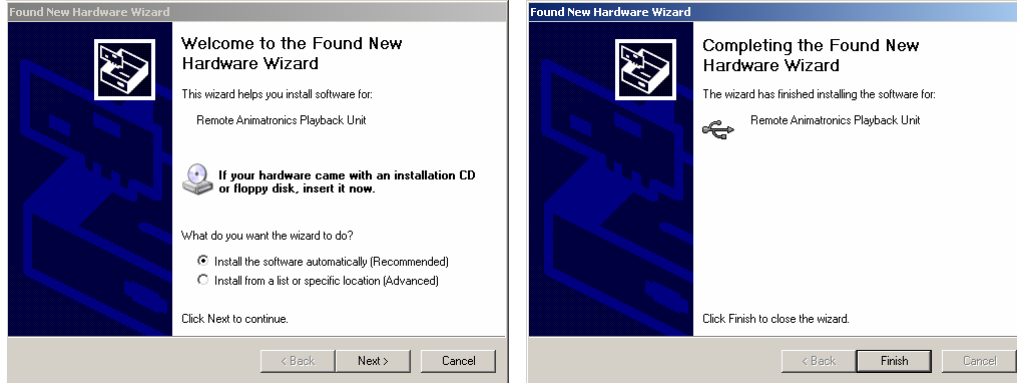

The Hardware Wizard will locate and install the appropriate drivers for Windows XP. When finished, the click “Finish” and begin to use your RAPU device.

### 1.5.2 Windows Vista

When installing RAPU Manager, you may receive the following Security Warning (left). After verifying that the file name is correct and the software was provided from Brookshire Software, LLC, press “Run” to continue. If User Account Control (UAC) is enabled or you are logged on without Administrator privileges, you may be prompted for the Administrator password.

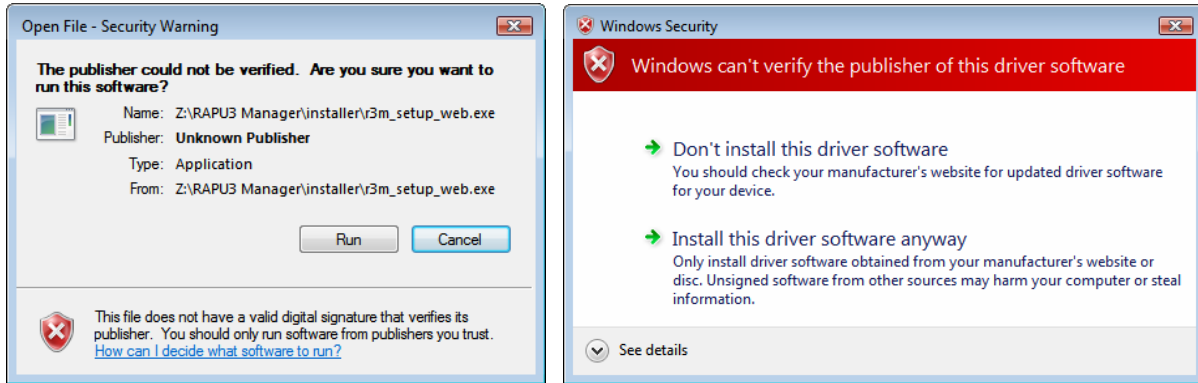

During installation, the installer will register the device drivers required for proper RAPU operation. The above (right) Windows Security warning may appear. Select “Install this driver software anyway” both times. When linking the RAPU to the PC with USB (see Section 2.2) for the first time on Windows Vista, you may see the following two notifications. You are now ready to use your RAPU device.

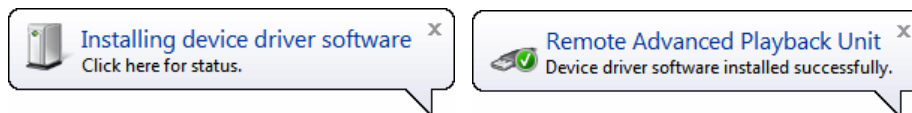

## 1.6 Setting up the RAPU

After unpacking the RAPU and verifying that all components are included, several connections should be made to your external hardware. Refer to Section 1.2 for the locations of connectors.

1. Connect the stereo audio jacks (3) to the speaker or amplifier system. Refer to the Technical Specifications for details.
2. Connect the device serial port (2), the DMX output port (5), or the TTL port (14) to servo, motor, dimmer, or relay control hardware. For example, the serial port would connect through a 9-pin straight-through cable to the MiniSSC/SMI/SV203/Parallax/Pololu/PicoPic/SSC32/K108A control board. The TTL port (14) is compatible with the Parallax TTL serial port. The device serial port, the DMX output port, and/or the TTL port cannot be used simultaneously.
3. Insert the SD/SDHC card (not included) into the SD/SDHC slot (9).
4. Optionally, connect the control serial port (1) to a microprocessor, other embedded control device, or PC. The control serial port is RS232 compatible.
5. Optionally, connect the USB port (8) to the PC to upload routines to the SD/SDHC card. If you plan to use the RAPU as a repeater (see Section 2.6), the USB connection must be made to the PC.
6. Plug the included power adapter into the wall and, then, into the RAPU power connector (6). The RAPU will immediately power on and a screen similar to the following will be displayed:

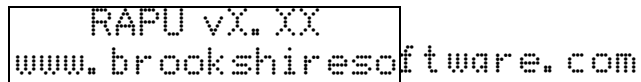

```
RAPU vX.XX
www.brookshiresoftware.com
```

## 1.7 Mounting

The RAPU comes with four 4-40 threaded hex nut standoffs which can be used as mounting points. These standoffs are not grounded on the RAPU. Furthermore, care should be taken to insulate the RAPU and shield it from interference.

# 2 Using the RAPU

## 2.1 Creating Routines

The routines created on VSA can be directly exported to the RAPU where playback will exactly match that of the PC. For details on how to use VSA to author routines, refer to the **VSA Help** documentation included with VSA. Once you have completed the routine in VSA, select **Tools** and then **RAPU Export...** Refer to the VSA Help documentation for details about the different RAPU export settings. Note the directory to which you save the “.rapu” file.

For the best performance, author routines with an MP3 file which has a 44.1kHz sample rate and a 128kbps data rate. If the MP3 file associated with the routine does not adhere to these standards, the RAPU Manager will automatically convert the MP3 file. The MP3 conversion process may slightly alter the timing characteristics of the audio and result in a timing mismatch with the animation data. An MP3 file with a 44.1kHz sample rate and a 128kbps data rate will not require conversion and will best match the original VSA routine. This

conversion process may require an MP3 encoder which is not included with the RAPU Manager (see [http://www.brookshiresoftware.com/rapu3\\_faq.htm](http://www.brookshiresoftware.com/rapu3_faq.htm) for more details).

## 2.2 Uploading .rapu files

Once the RAPU Manager is installed (see Section 1.5), the .rapu file can be directly uploaded to the RAPU using the USB interface.

1. Power on the RAPU and insert a SD/SDHC card.
2. Connect the RAPU to your PC's USB 1.1/2.0 port using the provided cable.
3. Verify that the RAPU Manager software has been properly installed (see Section 1.5)
4. From the RAPU's **MAIN MENU** select **Setup USB Link**. This will establish a USB connection with the PC.
5. Start the **RAPU Manager** software on your PC.
6. Press the **Refresh** button to detect any recently installed devices.
7. From the drop-down list to the left of the Refresh button, select the desired RAPU device. If the proper RAPU is not listed, then the RAPU has not been successfully detected by the system.
8. Select **Add routine...** and open the desired .rapu file. The progress bar will indicate status as the file is uploaded to the RAPU. If the proper MP3 encoding files are installed, the audio file will be converted to the appropriate MP3 format, if necessary. Otherwise, you may be prompted to install additional MP3 encoding tools. Visit [http://www.brookshiresoftware.com/rapu3\\_faq.htm](http://www.brookshiresoftware.com/rapu3_faq.htm) for details.

Routines may only be deleted from the end of the disk. Press **Remove last routine** to delete the last routine. The USB link may be disconnected by pressing *Enter* (11) on the RAPU. Be careful not to unplug the RAPU power or USB cables during an upload or delete procedure.

It is also possible to upload routines to SD/SDHC cards indirectly without using the RAPU. If your PC is equipped with a SD/SDHC card reader, it will also be recognized by the RAPU Manager. Because the RAPU Manager will overwrite all data on the selected drive, it is essential that you backup all data on your PC. Once you have completed your backup, connect the SD/SDHC card and proceed to Step 5 (above), selecting the appropriate disk drive instead of the RAPU. The RAPU Manager software will only recognize drives that are removable and do not contain the "C" partition. The RAPU Manager software will erase all data on the selected drive.

## 2.3 Playing routines

The RAPU will display all detected routines in the **MAIN MENU**. Press *Next* (10) to scroll through the available options. When you wish to start playback, press *Enter* (11) when the desired routine's title is shown.

```
MAIN MENU
my_routine1
```

During playback, the routine's title and the current playback time will be displayed. Press *Next* to scroll through the available options (**FWD**, **STOP**, and **REV**). To skip to the next routine, press *Enter* when **FWD** is displayed; to return to the previous routine, press *Enter*

when REV is displayed. To halt playback and return to the MAIN MENU, press *Enter* when STOP is displayed.

```
my_routine1
STOP          0: 10
```

The RAPU has a number of playback options which determine which routine is played after one completes. From the MAIN MENU, press *Next* until the Options Menu is displayed. Press *Enter* and the OPTIONS MENU is presented. Use *Next* to scroll through the available options and press *Enter* when the desired playback mode is displayed. An asterisk (\*) will appear next to the currently selected playback mode.

Play Once – Play the selected routine once and then stop playback.

Loop All – Play the all routines in order continuously.

Repeat Single – Play the selected routine continuously.

Random – Continue to randomly select a routine to play.

During playback or from any menu, use the +VOL (12) and -VOL (13) keys to raise or lower the volume of the audio.

## 2.4 Error messages

Insert flash card – A flash card was not detected, please insert a flash card and upload routines (see Section 2.2).

Remove card Card inserted improperly – The flash card is either inserted improperly or the type of card is not supported. The RAPU supports both SD and SDHC type memory cards.

## 2.5 IR Remote control

All playback functions of the RAPU may be controlled remotely with the IR remote control. There must be an unobstructed line of sight between the remote control and the IR receiver (7) on the RAPU. The following listing describes the functionality of the remote control; keys that are not listed are not supported.

The following keys are supported in “TV” and “VCR” mode (press the TV or VCR button to select the remote control mode):

CHANNEL UP – This key scrolls through the list of available options and is similar to pressing the *Next* key.

CHANNEL DOWN – This key scrolls through the list of available options in reverse.

VOLUME UP – This key increases the volume and is similar to pressing the +VOL key.

VOLUME DOWN – This key decreases the volume and is similar to pressing the -VOL key.

RETURN or ENT or ENTER – This key is similar to the *Enter* key.

MUTE – This key sets the volume to zero.

NUMBER KEYS (0-9) – To start play of a specific routine, key in the routine’s number. The routines are 1-based (i.e., the first routine can be started by pressing “1”).



The following keys are supported only in the “VCR” mode:

*PLAY* – This key is similar to the *Enter* key.

*STOP* – This key will halt a playback in progress.

*REW* – In the **MAIN MENU** and **OPTIONS MENU**, this key functions similar to the *CHANNEL DOWN* key. During playback, this key immediately moves play to the previous track.

*FF* – In the **MAIN MENU** and **OPTIONS MENU**, this key functions similar to the *CHANNEL UP* key. During playback, this key immediately moves play to the next track.

### **2.5.1 Programming the IR remote control**

The remote control is a universal remote which must be configured for the RAPU. Before the first use or if the remote should lose its configuration (e.g., when batteries are replaced), it will be necessary to reprogram it. Use the following directions, depending on the model of the remote. The model number may be found on the back of the remote or the underside of the battery compartment.

#### **Universal RCA Remote RCR350**

1. Press and hold the TV key. The LED indicator light turns on and remains on.
2. While holding down the TV key, enter the code 1-0-0-2 using the number keys (0-9) on the keypad. While you are pressing the numbers, the LED indicator light turns off.
3. After the fourth number is entered, the LED indicator light turns on. At this time, release the TV key.
4. Press and hold the VCR key. The LED indicator light turns on and remains on.
5. While holding down the VCR key, enter the code 2-0-9-9 using the number keys (0-9) on the keypad. While you are pressing the numbers, the LED indicator light turns off.
6. After the fourth number is entered, the LED indicator light turns on. At this time, release the VCR key.

#### **Radio Shack 3-IN-ONE Remote 15-2147**

1. Press and release the VCR button (the INDICATOR LIGHT will blink).
2. Press and hold the P button until the INDICATOR LIGHT blinks twice, then release the P button.
3. Enter the code 0-0-3-2 using the Number Buttons. After your code is entered, the INDICATOR LIGHT will blink twice.
4. Press and release the TV button (the INDICATOR LIGHT will blink).
5. Press and hold the P button until the INDICATOR LIGHT blinks twice, then release the P button.
6. Enter the code 0-0-0-0 using the Number Buttons. After your code is entered, the INDICATOR LIGHT will blink twice.

#### **Universal RCA Remote RCU410 and RCU404**

1. Press and hold the CODE SEARCH button until the INDICATOR LIGHT lights, then release the CODE SEARCH button.
2. Press and release the TV button (The INDICATOR LIGHT will blink then remain lit).
3. Enter the code 0-0-2 using the Number Buttons. After your code is entered, the INDICATOR LIGHT will turn off.

4. Press and hold the CODE SEARCH button until the INDICATOR LIGHT lights, then release the CODE SEARCH button.
5. Press and release the VCR button (The INDICATOR LIGHT will blink then remain lit).
6. Enter the code 0-9-9 using the Number Buttons. After your code is entered, the INDICATOR LIGHT will turn off.

### **Radio Shack 3-IN-ONE Remote 15-2143**

1. Press and hold the CODE SEARCH button until the red indicator stays on, and then release the CODE SEARCH button.
2. Press and release the TV mode button. The red indicator blinks, and then stays lit.
3. Enter the three digit code 4-1-4. Note: after a valid code entry, the red indicator turns off. For an invalid code, the red indicator flashes.

## **2.6 Repeater Operation**

The RAPU can also be used as a USB-to-serial repeater. When acting as a repeater, the RAPU simply passes commands from VSA sent across the USB port to the serial or DMX ports. When acting as a repeater, the RAPU can be used to convert legacy serial devices to USB and control DMX devices. Audio playback will be through VSA on the PC's speakers; the audio output on the RAPU will not be used.

1. Follow steps (1) through (4) in Section 2.2. Do not start the RAPU Manager.
2. Start VSA. VSA must be started after the RAPU is linked via USB to the PC.
3. See the VSA help files for detailed support. The RAPU will be listed along with serial and parallel ports as a device output port.

## **2.7 Scheduler**

The RAPU has an internal digital clock which can be used to trigger playback at predefined dates and times. The scheduler can be used to trigger the same routine to playback at many different times and to trigger multiple routines at different times. There are several key features of the RAPU's scheduler:

- The on-board battery backup will maintain the clock when the RAPU is powered off. However, power (6) must be connected for playback to execute.
- The scheduler allows trigger time and dates to be specified – whenever the internal digital clock satisfies a trigger event, the specified routine will be started.
- The scheduler does not run while playback is in progress, so routines will not be interrupted by other routines.
- The resolution of the scheduler is one minute. If a routine is less than a minute long, it may be triggered by the scheduler multiple times. To circumvent this behavior, ensure that all events are longer than a minute in duration.
- The playback mode will be honored, so if a mode other than “play once” is specified, the scheduler will only run until the first trigger. As a result, when using the scheduler, it is often intended to have the playback mode set to “play once.”
- If two or more trigger events are satisfied simultaneously but associated with different routines, one of the routines will be chosen to play (the manner in which the routine is chosen is undefined).

### 2.7.1 Set the date and time

The internal digital clock will be set whenever the schedule is edited via the RAPU Manager.

1. Follow steps (1) through (5) in Section 2.2.
2. Select **Edit Schedules...**
3. Create or modify any entry and press **OK**. The RAPU time will be automatically synchronized to your PC's internal time.

Alternatively, the RAPU time can be set via the Control serial port. See Section 2.8 for details on using the `time` command.

### 2.7.2 Schedule events

1. Follow steps (1) through (5) in Section 2.2.
2. Select Edit Schedules...
3. Select Add to create a new schedule, double click on an existing schedule to edit it, or select Remove to delete an existing schedule.

The first column, **Track**, specifies the track that will be started when this event is triggered. The **Minutes**, **Hours**, **Weekdays**, **Days of month**, and **Months** determine what dates and times will trigger the event. Each of these fields may contain a list of values separated by commas or an asterisk (\*). An asterisk means that any value will satisfy this field. A single value or a list of values specifies that only the provided values will satisfy this field. When all fields are satisfied, the event will trigger.

The following table shows several examples and descriptions of when playback will occur. Minutes have values ranging from 0-59, hours 0-23 (Military time), weekdays 1-7 (1=Sunday, 7=Saturday), days of month 1-31, and months 1-12 (1=Jan, 12=Dec).

Track	Minutes	Hours	Weekdays	Days of month	Months	Description
0	0, 5, 10, 15, 20, 25, 30, 35, 40, 45, 50, 55	12, 16	*	*	*	Play routine 0 every five minutes between 12:00pm and 12:59pm and 4:00pm and 4:59pm on every day.
32	0	*	2, 4		1	Play routine 32 at 2:00am and 4:00am every day during January.
13	*	*	*	1, 10, 20, 30	1, 12	Play routine 13 repeatedly during the 1 <sup>st</sup> , 10 <sup>th</sup> , 20 <sup>th</sup> , and 30 <sup>th</sup> of December and January. Note, if a month does not have a 30 <sup>th</sup> day, for example, it will be ignored for that month.

## 2.8 Control serial port

Many of the RAPU's operations may be controlled through the control serial port (1). The serial port operates at 19.2kbps, 8 data bits, one stop bit, and no parity. The port implements

a standard RS232 interface and conversion circuitry may be required to interface to a TTL serial port (e.g., Basic Stamp or other microcontroller). The port provides a console-like interface that is designed for human or automated operation. A typical terminal interaction might resemble the following:

```
RAPU vX.XX
www.brookshiresoftware.com
>ls
000: my_routine1
001: my_routine2
002: my_routine3
>play 0
>status
p 0 239
>
```

The console is prepared to receive input when the “>” prompt is displayed. Several functions are unavailable (e.g., list) when playback is in progress because these functions would otherwise interfere. Care should be taken not to constantly poll the RAPU during playback (e.g., to check to see if playback is complete) as the control serial port interface can consume processor resources. For the most reliable performance, queries should be limited to 1Hz during playback. Additionally, all commands are unavailable if a flash card is not inserted or the USB link is active.

reset, re

These commands will reboot the RAPU.

list, ls

These commands will list all the track titles. The track titles will be listed in: “<track number>: <track title>” format. This command is not available when a routine is being played.

pm [mode]

If the optional [mode] parameter is supplied, this command sets the current playback mode. If the mode parameter is not supplied, this command retrieves the current playback mode (0:play once, 1:repeat single, 2:loop all, 3:random play). This command is not available when a routine is being played.

play <track number>

This commands starts playback and requires an argument that indicates the number of the track to play (e.g., the first track is track zero).

vol [volume]

This command sets the volume if the optional parameter [volume] is supplied. Otherwise, this command returns the current volume.

status

This command retrieves the current state of the RAPU unit. The command will return “s” if the unit is stopped. The command will return “p <track number> <frame>” if a routine is being played. The current time can be determined by dividing the returned frame argument by the frames per second rate of the routine.

stop

This command halts all playback.

time [MM-DD-YY HH:MM:SS]

If the optional date and time are not provided, this command prints the current time in “MM-DD-YY HH:MM:SS” format. If the date and time are provided in the specified format, the internal date and time are set.

help, ?

These commands will print a summary of all available commands.

## 2.9 Upgrading the Firmware

The RAPU will come preprogrammed with the most recent firmware version. Bug fixes and feature enhancements may require a firmware update. It is recommended that you only update the firmware when instructed to do so by Brookshire Software, LLC. Unnecessary firmware upgrades will shorten the life of the RAPU and incomplete or failed firmware updates may permanently damage the RAPU. If you are unsure if a firmware update is necessary, contact Brookshire Software, LLC at [techsupport@brookshiresoftware.com](mailto:techsupport@brookshiresoftware.com) for assistance.

1. Download the most recent firmware image file (the extension will be “.img”) from [www.brookshiresoftware.com](http://www.brookshiresoftware.com).
2. Power on the RAPU.
3. Connect the RAPU to your PC’s USB 1.1/2.0 port using the provided cable. Verify that only one RAPU is connected to your PC.
4. Verify that the RAPU Manager software has been properly installed (see Section 1.5).
5. On the underside of the RAPU, there are two small dip switches (adjacent to the SD/SDHC connector). Flip the dip switch labeled “I” to the “ON” position.
6. Press and release the nearby *RESET* button.
7. Flip the dip switch labeled “U” to the “ON” position.
8. The RAPU will connect to the PC via USB as an “Remote Animatronics Playback Unit (firmware)” device.
9. Start the **RAPU Manager** software.
10. No devices will appear since the RAPU is in a special firmware upgrade mode. Press **Load firmware....** Follow the on screen directions if you have not already done so above.
11. Select the appropriate image file to begin programming.
12. When programming is complete, flip the dip switch labeled “U” and “I” to the “OFF” positions.
13. Press and release the nearby *RESET* button.